

高輝度白色
表面実装
トップビューパッケージ

High-Brightness White
SMD Top View Package

LW822 series

特徴 FEATURES

- 高輝度
High Brightness
- 小型表面実装パッケージ
Small SMD Package

用途 APPLICATIONS

- 表示灯
Indicators
- 電飾
Illuminations
- 遊技機器
Amusement
- 照明
Lighting

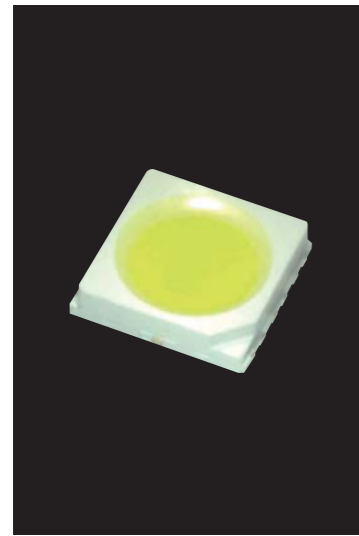

品番 Part No.	発光色 Emitted Color	チップ Chip	特徴 Features	サイズ(mm) Size
LW822-001	●	2in1	1.5Wタイプ・超高輝度 / 1.5W Type・Super High Brightness	5.4×5.0 t=1.2
LW822-002	●	2in1	1.5Wタイプ・超高輝度 / 1.5W Type・Super High Brightness	

最大定格
MAXIMUM RATINGS

Item	逆電圧 Reverse Voltage	順電流 Forward Current	許容損失 Power Dissipation	動作温度 Operating Temp.	保存温度 Storage Temp.	半田付け温度 Soldering Temp.*	
Symbol	V _R	I _F	P _D	T _{opr.}	T _{stg.}	T _{sol.}	
Unit	V	mA	mW	°C	°C	°C	
Data	LW822-001 LW822-002	5	400 (200×2chip)	1,440	-40~+85	-40~+100	260

Ta=25°C
※最大5秒以内
Maximum 5s

電気的光学的特性
ELECTRO-OPTICAL CHARACTERISTICS

Item	順電圧 Forward Voltage			色度 Chromaticity Coordinates	光度 Luminous Intensity			光束 Luminous Flux	平均演色性評価数 General Color Rendering Index	指向角 Viewing Angle	順電流条件 IF Conditions
	Min.	Typ.	Max.		Min.	Typ.	Max.				
Symbol	V _F			(x, y)	I _v			φ _V	Ra	2θ1/2	
Unit	V			-	cd			lm	-	deg	mA
Data	LW822-001 LW822-002	2.8 3.2	3.6	(0.330, 0.340) (0.410, 0.390)	21.5 19.5	27.5 23.4	31.0 28.5	(76.7) (65.2)	- -	120	240 (120×2chip)

Ta=25°C

外形寸法
DIMENSIONS (Unit : mm)

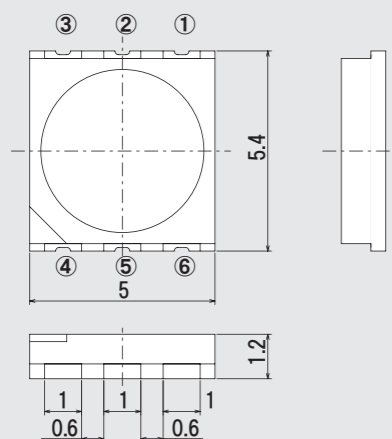

PIN Connections
①③ Anode
④⑥ Cathode

推奨ランドパターン図(Recommended Soldering Pattern)

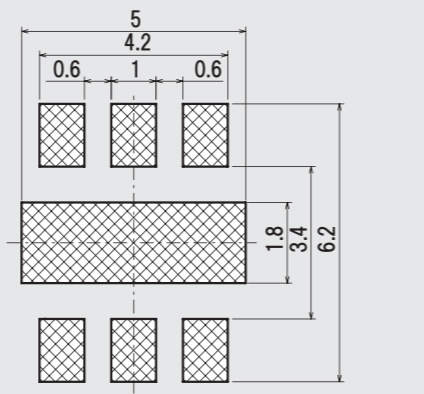

色度ランク分類
CHROMATICITY COORDINATES RANK

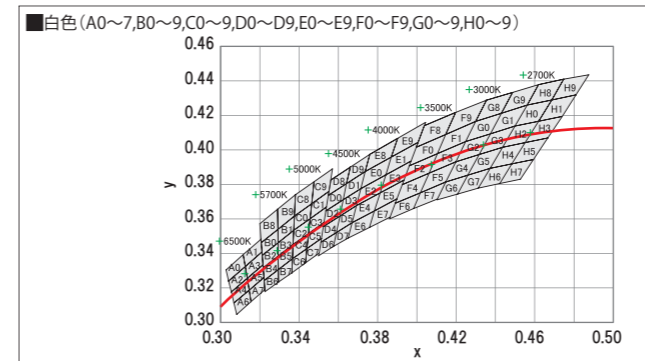

順電流 - 周囲温度特性
Forward current vs. Ambient temperature

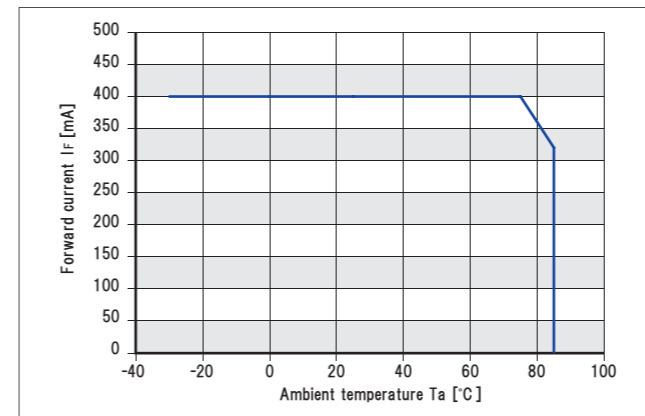

光度 - 順電流特性
Relative luminous intensity vs. Forward current (Ta=25°C)

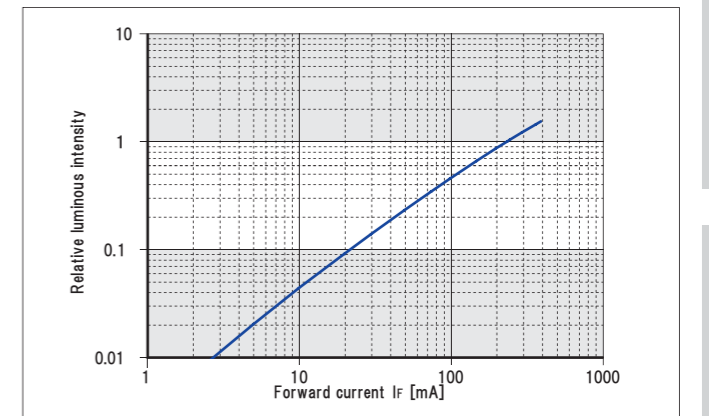

発光波長分布特性
Relative luminous intensity vs. Wavelength (Ta=25°C)

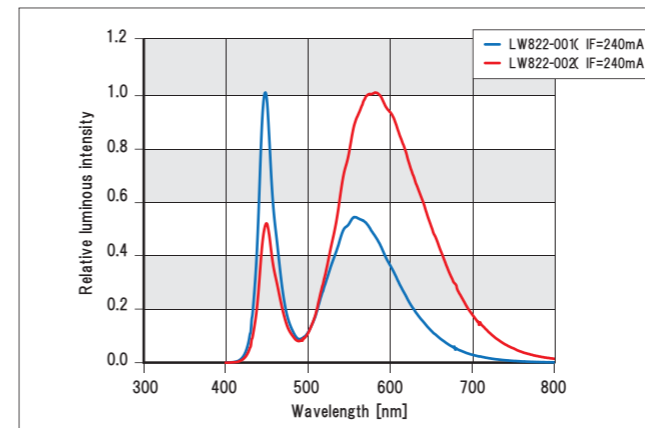

順電流 - 順電圧特性
Forward current vs. Forward voltage (Ta=25°C)

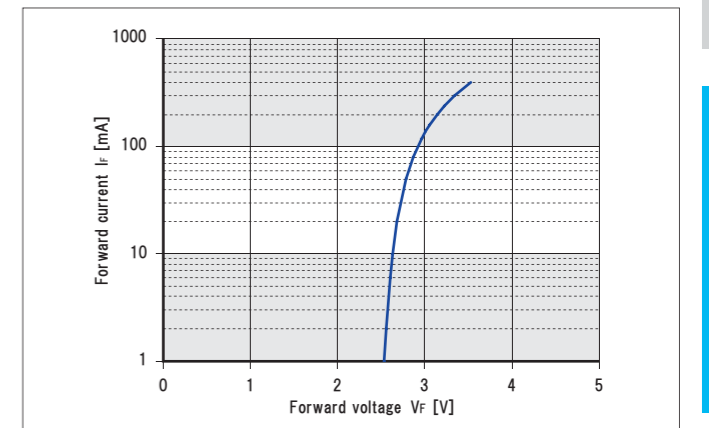

指向特性
Radiation pattern

