

高輝度白色
表面実装
トップビューパッケージ

High-Brightness White
SMD Top View Package

NEW

LW813 series

URL <http://www.kodenshi.co.jp>
E-mail info-rd@kodenshi.co.jp

KODENSHI CORP.

特徴 FEATURES

- 高輝度
High Brightness
- 小型表面実装パッケージ
Small SMD Package

- 高演色性
High Color-Rendition

用途 APPLICATIONS

- 表示灯
Indicators
- 電飾
Illuminations

- 遊技機器
Amusement
- 照明
Lighting

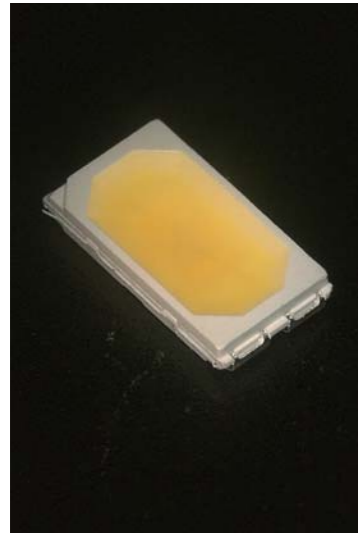

品番 Part No.	発光色 Emitted Color	チップ Chip	特徴 Features	サイズ(mm) Size
LW813-1**4080	●	1in1	0.5Wタイプ・高輝度・高演色 / 0.5W Type・High Brightness・High Color-Rendition	5.6×3.0 t=0.9
LW813-1**5080	●	1in1	0.5Wタイプ・高輝度・高演色 / 0.5W Type・High Brightness・High Color-Rendition	

最大定格 MAXIMUM RATINGS

Item	逆電圧 Reverse Voltage	順電流 Forward Current	許容損失 Power Dissipation	動作温度 Operating Temp.	保存温度 Storage Temp.	半田付け温度* Soldering Temp.*
Symbol	V _r	I _F	P _d	T _{opr.}	T _{stg.}	T _{sol.}
Unit	V	mA	mW	°C	°C	°C
Data	LW813-1EC*** 5	150	510	-30~+85	-40~+100	260

Ta=25°C
*最大5秒以内
Maximum 5s

電気的光学的特性

ELECTRO-OPTICAL CHARACTERISTICS

Item	順電圧 Forward Voltage			色度 Chromaticity Coordinates	光度 Luminous Intensity		光束 Luminous Flux	平均演色性評価数 General Color Rendering Index	指向角 Viewing Angle	順電流条件 IF Conditions		
	Min.	Typ.	Max.		Min.	Typ.					Max.	
Symbol	V _F			(x, y)	I _v		φV	Ra	2θ1/2			
Unit	V			-	cd		lm	-	deg	mA		
Data	LW813-1**4080	-	2.9	-	(0.385, 0.380)	-	9.1	-	(25.5)	80	120	60
	LW813-1**5080	-	2.9	-	(0.345, 0.355)	-	9.2	-	(25.6)			

Ta=25°C

外形寸法

DIMENSIONS (Unit : mm)

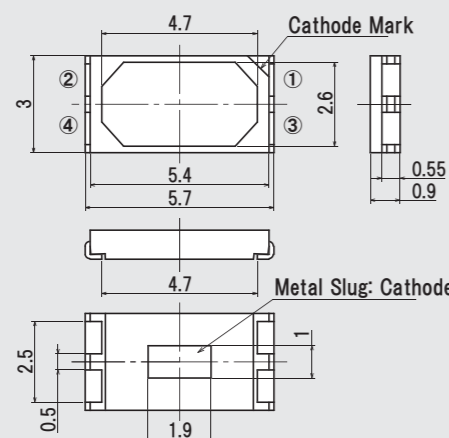

PIN Connections
① Cathode
② N.C.
③ N.C.
④ Anode

色度ランク分類 CHROMATICITY COORDINATES RANK

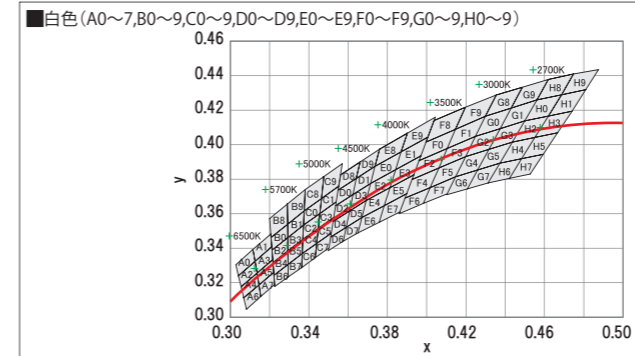

順電流 - 周囲温度特性 Forward current vs. Ambient temperature

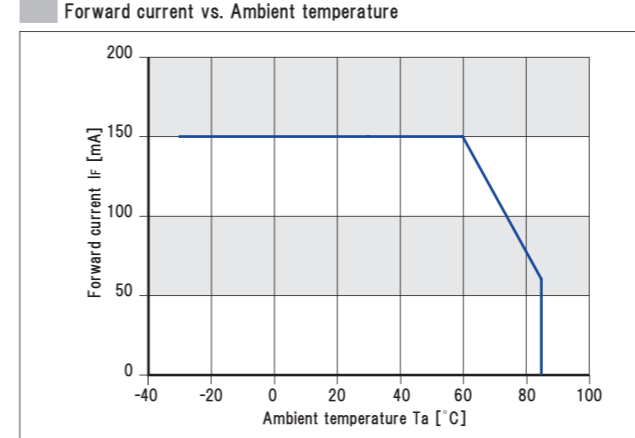

光度 - 順電流特性 Relative luminous intensity vs. Forward current

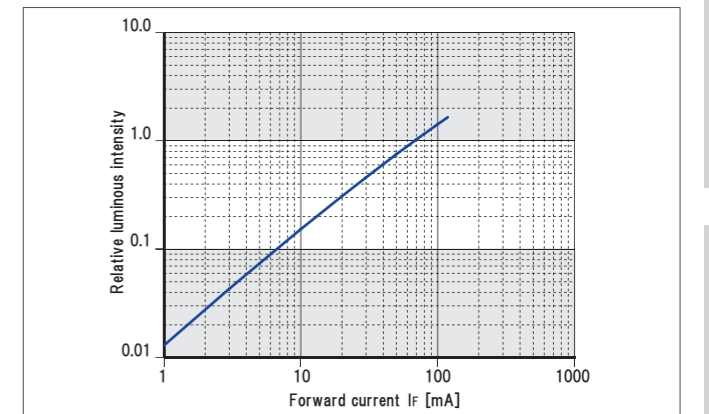

発光波長分布特性 Relative luminous intensity vs. Wavelength

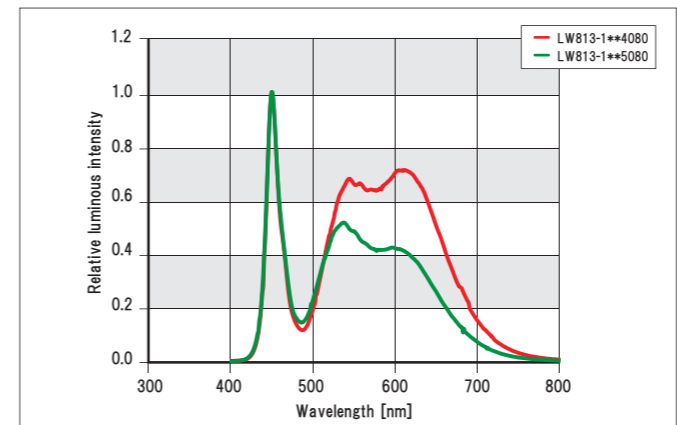

順電流 - 順電圧特性 Forward current vs. Forward voltage

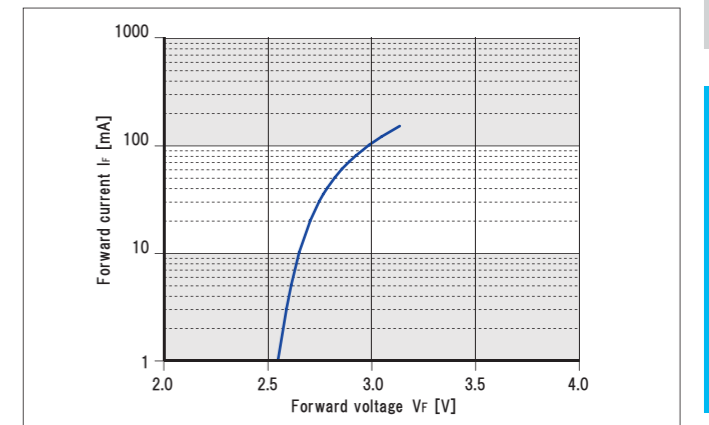

指向特性 Radiation pattern

